

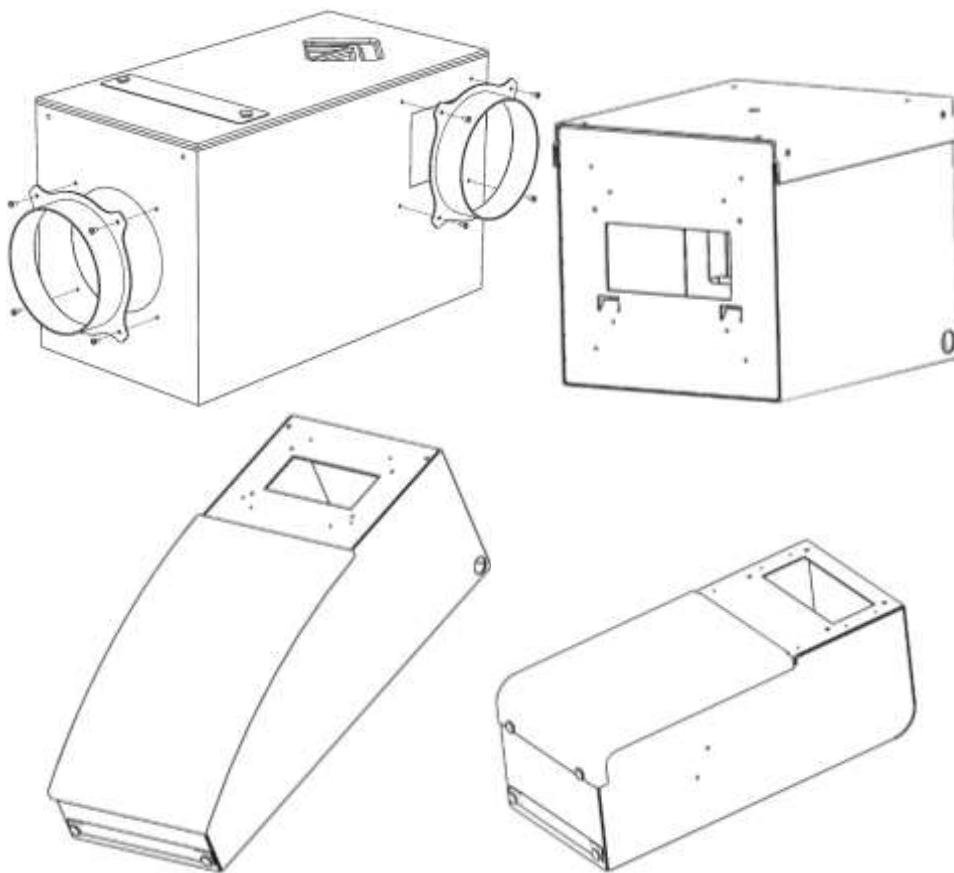

VENTILAIRSEC
La ventilation dans le bon sens

Installation Manual VMI® PULSE'R Prestige 2 / Prestige 2+



PULSE'R®



Important information:

This manual explains how to install and maintain VENTILAIRSEC's VMI® PULSE'R Prestige 2 / Prestige 2+ units

Certain operations must only be carried out by qualified staff and must not be carried out by the user under any circumstances.

May 2015 edition

Table of contents:

1	GENERAL INFORMATION	4
1.1	ABOUT THIS MANUAL	4
1.2	SAFETY INSTRUCTIONS	4
2	DESCRIPTION OF THE APPLIANCE.....	6
2.1	OVERVIEW	6
2.2	TECHNICAL CHARACTERISTICS	7
2.3	DIMENSIONS.....	8
2.4	PRESENTATION OF THE REMOTE CONTROL	10
3	INSTALLATION	13
3.1	PREPARATION	13
3.2	LOCATION	13
3.3	VENTILATION OPENINGS.....	14
3.4	HOUSINGS.....	15
3.5	ROOF OUTLET	17
3.6	DUCT NETWORK	17
3.7	SUMMARY OF THE INSTALLATION	19
3.8	ELECTRICAL CONNECTION	20
3.9	REMOTE CONTROL	20
3.10	AIR EXTRACTION POINTS.....	20
3.11	DOOR UNDERCUTS.....	21
4	COMMISSIONING.....	21
4.1	PROPER COMPLETION CHECKS	22
4.2	POWERING UP FOR THE FIRST TIME / PAIRING	22
4.3	ACCESSING THE INSTALLER MODE/CONFIGURATION MODE	22
4.4	SETTING THE RATED SPEED/FILTER DURATION	24
4.5	CONSUMPTION AND OPERATING TIME SCREEN	24
4.6	TROUBLESHOOTING.....	25
4.7	VERSION SCREEN	26
4.8	EXITING THE INSTALLER MODE	26
4.9	INITIAL SETTINGS	26
5	GETTING STARTED	28
6	CARE	28
6.1	FILTER	28
6.2	RESETTING THE FILTER COUNTER	29
6.3	BATTERIES.....	29
6.4	SD CARD.....	29
6.5	AIR INLETS AND OUTLETS.....	30
6.6	CLEANING/CHECKING	30
7	GLOSSARY.....	31

1 General information

1.1 About this manual



- Danger/Important information. This symbol indicates important information that must be observed to prevent any risks of physical injury and/or damage to equipment.



- Must only be done by qualified staff.



- Can be done by the user.

- Read this manual carefully to ensure optimal performance of the appliance.
- VENTILAIRSEC declines all liability if the instructions given in this manual are not followed.
- In this manual, the word "Premises" refers to the space to be ventilated, whether it be a house, offices or public premises.

1.2 Safety instructions

1.2.1 Installation

- The appliance must be handled and installed with means adapted to its weight.
- The appliance must be installed by qualified staff.
- Once the appliance has been installed, it must be put into operation quickly to avoid condensation building up.

1.2.2 Use

- This appliance is not intended for use by people (including children) with reduced physical, sensory or mental capacities, or by people with no experience or knowledge of the appliance, unless they are monitored by or have received instructions from someone responsible for their safety when using the appliance.
- Make sure that children do not play with the appliance.
- This appliance is designed exclusively for ventilating and circulating air and no other fluid.
- Do not insert anything in the ventilation ducts and do not obstruct the air inlets and air outlets.
- Do not place anything on the appliance.
- **The VMI® unit must never be turned off.**
- In case of abnormal functioning, contact the machine's installer.



1.2.3 Care and maintenance

- Disconnect the power supply before all interventions (except for maintenance that can be done by the user and defined below) and make sure that it cannot be accidentally reset.
- The user may only change the appliance's filter, the remote control's batteries and clean the air inlets and outlets, providing they follow the instructions given in this installation manual (part 6 Care).
- All other maintenance operations must be carried out by qualified staff.
- The user must not attempt to repair any breakdowns.
- If the power cable is damaged, it must be replaced by the manufacturer, its after sales service or by similarly qualified people to avoid any danger.
- You are advised to record all care and maintenance operations on the service history sheet at the end of the manual.

1.2.4 Transformation

- The appliance must not be modified. All components must be replaced by a professional and with genuine parts from the manufacturer.

1.2.5 End-of-life

- Before removing the appliance, power it down.
- Do not burn the appliance. Certain components may release toxic gases when they are burnt.
- Remove the batteries from the remote control and take the components to a recycling collection point.
- Take the product to a recycling collection point. The product must not be disposed of with household waste.



2 Description of the appliance

2.1 Overview

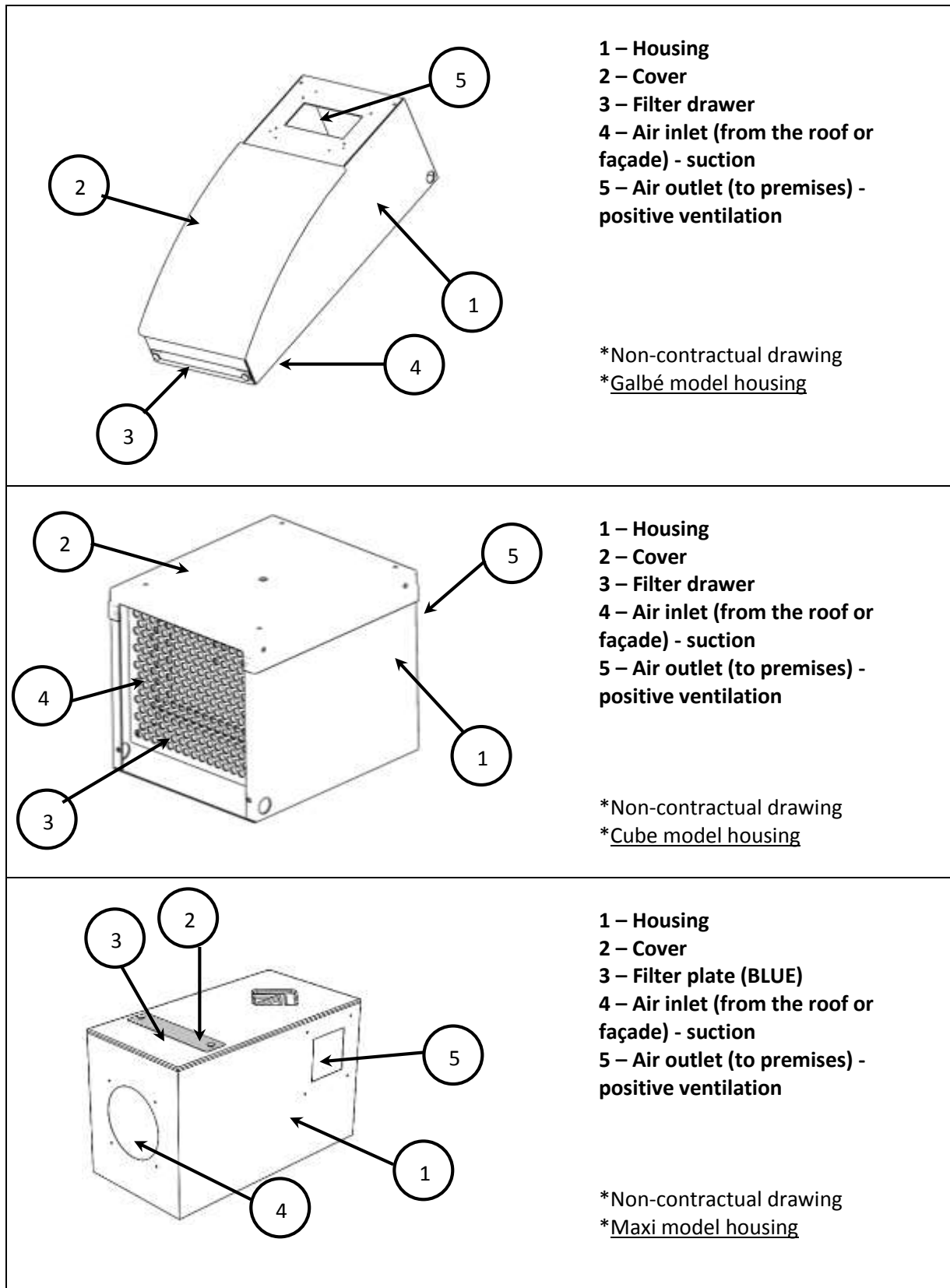

2.2 Technical characteristics

2.2.1 Operation

- Single phase 230 VAC, 50 Hz
- Maximum output for Galbé, Cube and Compact model housings: 1140 W
- Maximum output for MAXI model housing: 2220 W
- Electrical protection factor: IPX2
- Ambient operating temperature: -5°C/60°C
- Remote Control - VMI® Communication Radio Frequency: 868 MHz

2.2.2 Structure

- Weight: 11 kg (Galbé and Compact models) 10 kg (Cube model) 11.9 kg (Maxi model)
- Housing electrolytic zinc coated steel 1.5 mm thick - epoxy powder-coated paint RAL9010
- Cover: ABS AE UL94V0 3 mm thick 3 mm
- Grade F7 and G4 filters
- 2 connection pieces for 160 mm diameter ducts

2.2.3 Performance

- Air preheating: 12°C, 15°C, 18°C
- Maximum flow rate for Compact model: 170 m³/h
- Maximum flow rate for Galbé/Cube models: 218 m³/h
- Maximum flow rate for Maxi model: 400 m³/h
- Recommended size of premises to be ventilated:
 - from 59 m² to 140 m² (Galbé, Cube models),
 - from 32 m² to 136 m² (Compact model)
 - from 141 m² to 307 m² (Maxi model)

(Average renewal rate 0.5 vol/h, unchanging ceiling height of 2.5 m)

2.3 Dimensions

2.3.1 Housing

Galbé

Compact

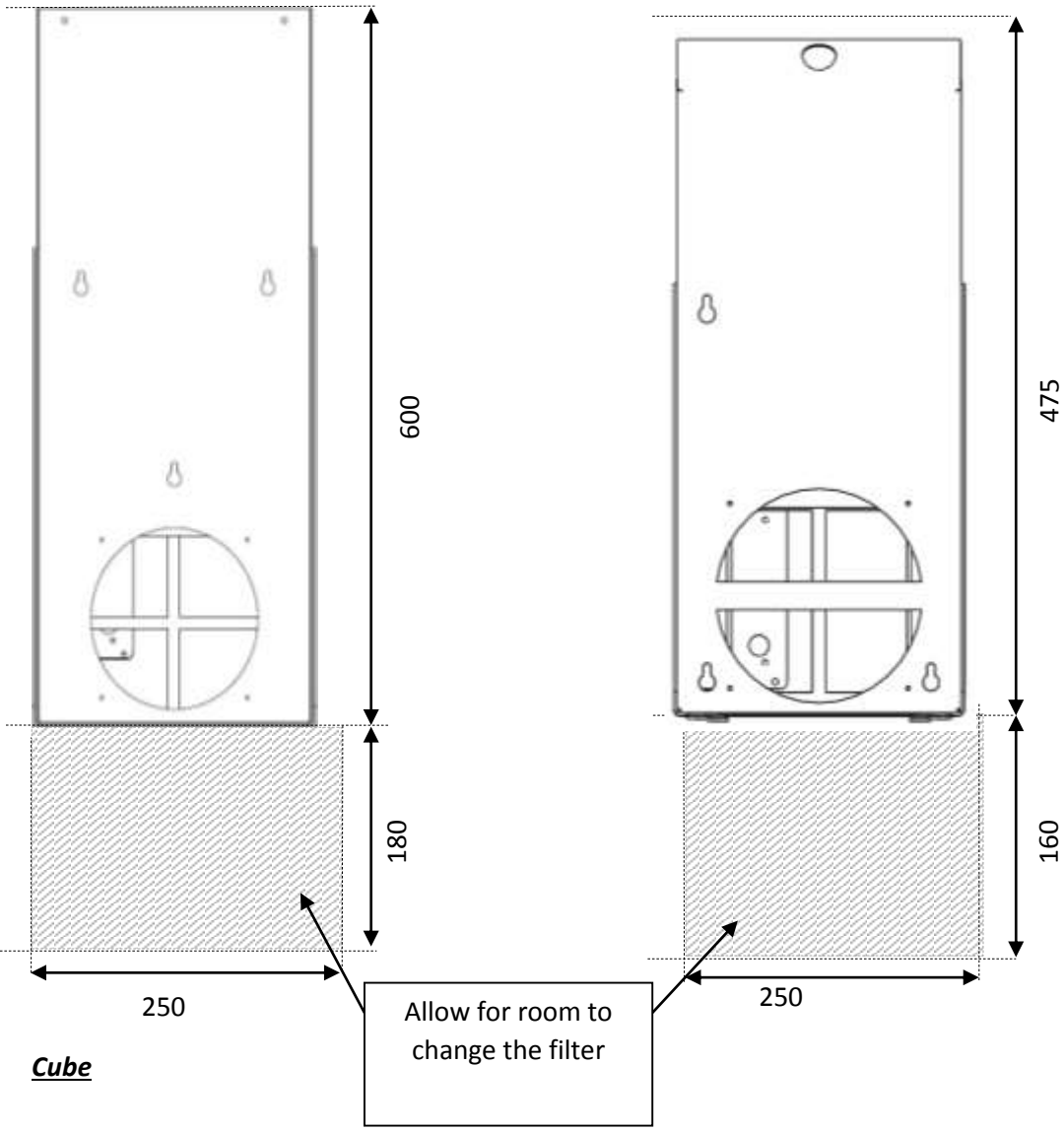

Cube

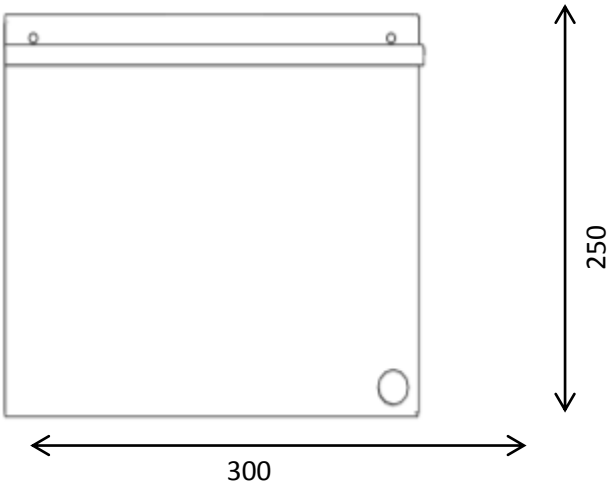
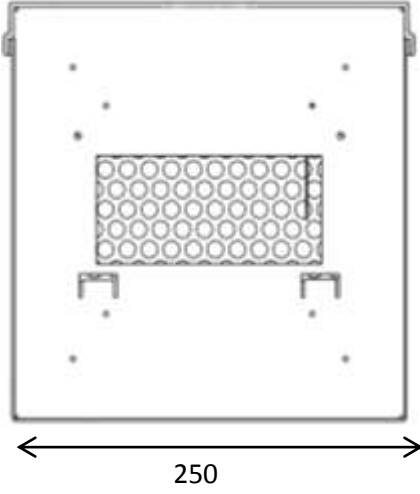

MAXI :

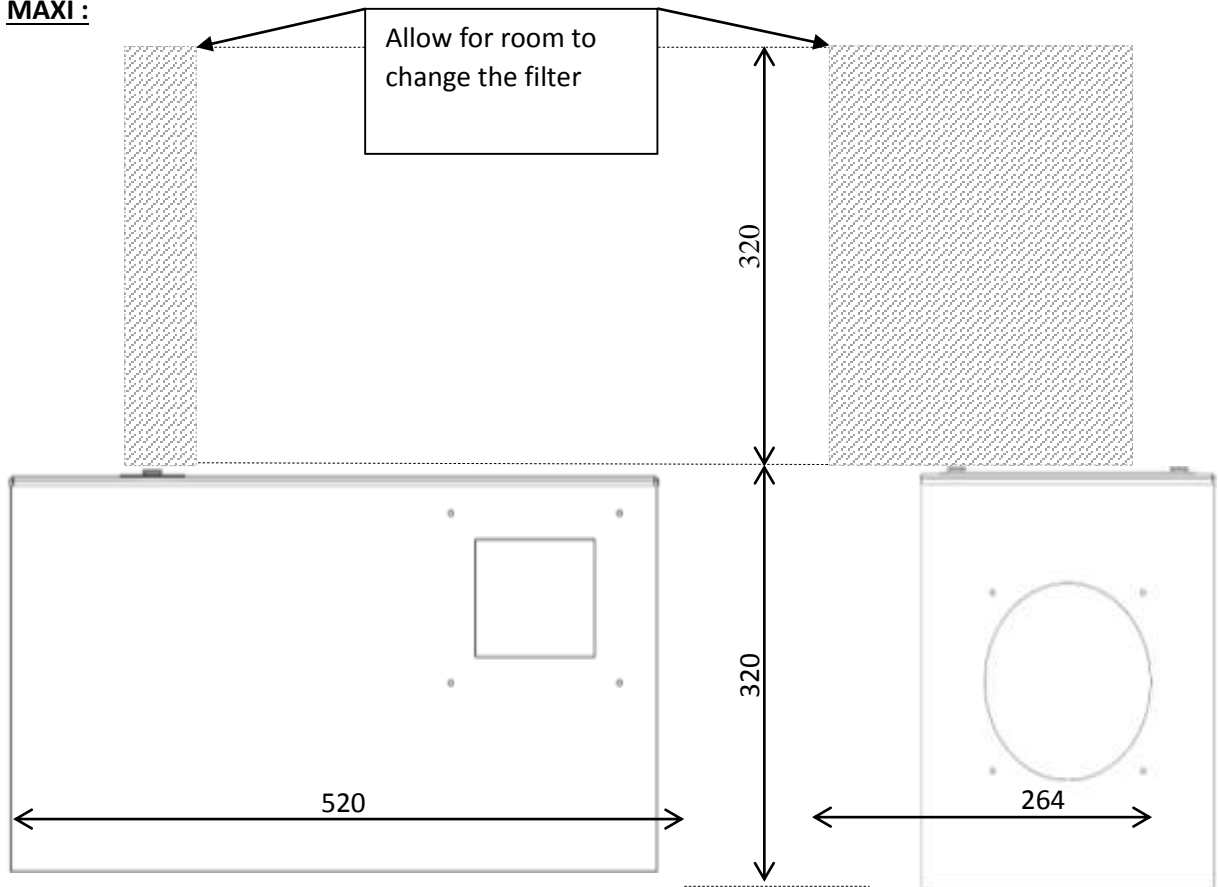

2.3.2 Remote control

Hole for wall mounting

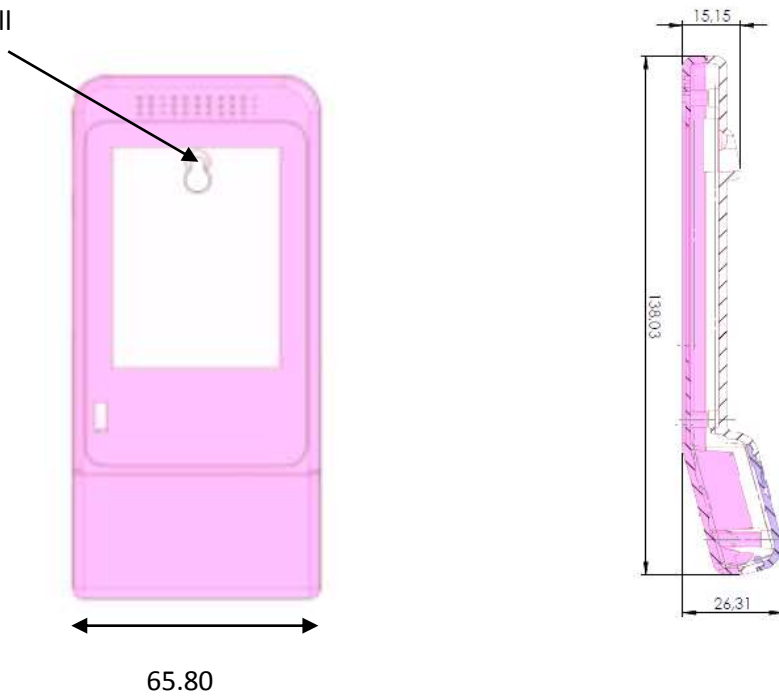

2.4 Presentation of the remote control

2.4.1 Front face

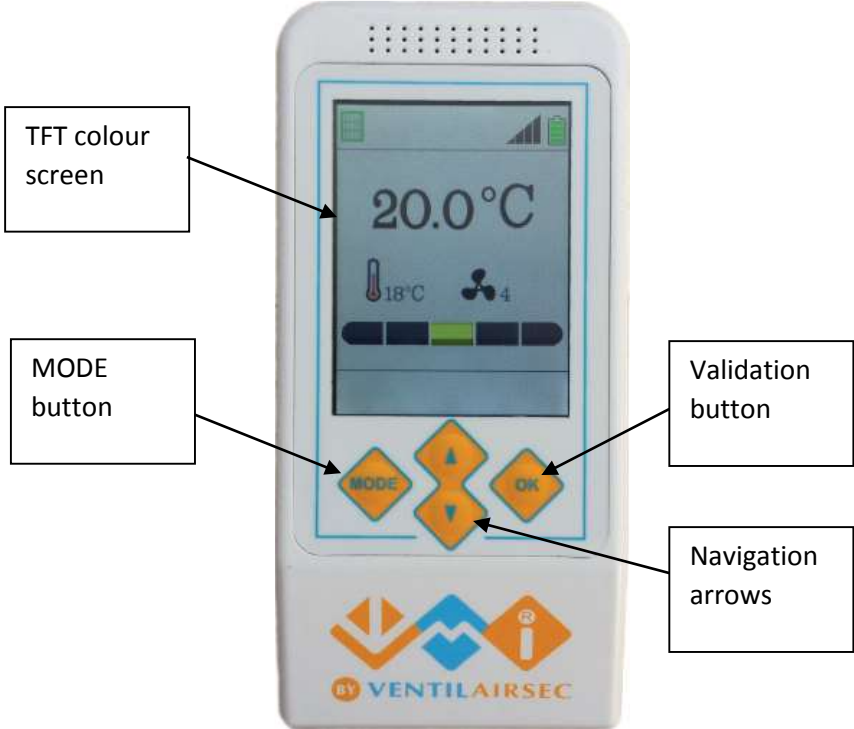

2.4.2 Rear face

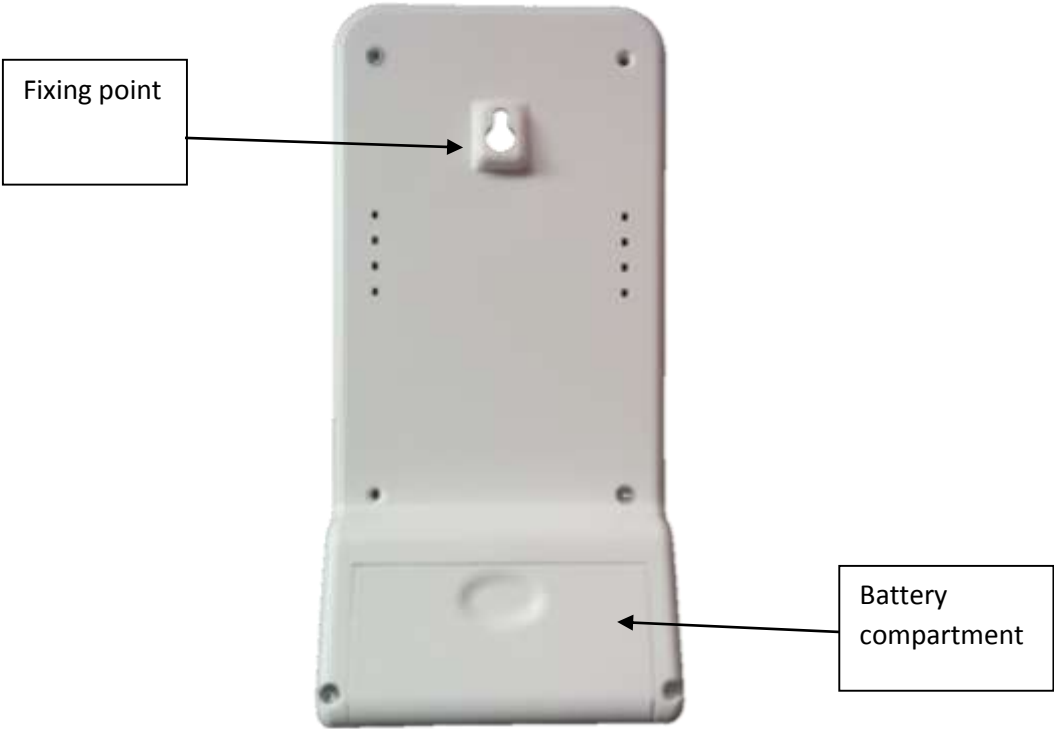

2.4.3 Displays

2.4.3.1 Presentation of the screens

To make it easy to use, the remote control has 7 interface screens. To change screens, you just need

to press the  button.



Main screen

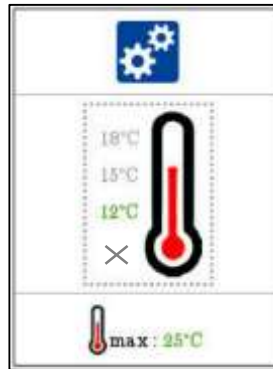

Set temperatures'
setting screen



Filter status screen

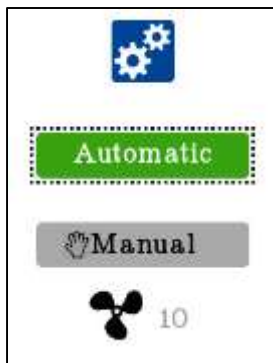

Control mode setting
screen

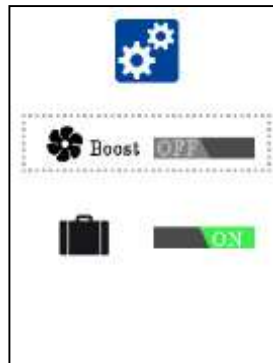

Options activation
screen



System test activation
screen











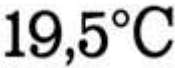





Installer settings
screen

Please note that the presentation of these screens is non-contractual. Certain parameters may be different depending on the settings and the indoor and outdoor environment.

2.4.3.2 Presentation of the pictograms

Main screen

	<p>Ambient temperature measured in the living area where the remote control is located.</p>
	<p>Air quality indicator according to humidity. The more the cursor is to the left, the drier the air; the more it is to the right, the more humid the air. The middle position corresponds to the most comfortable conditions.</p>
	<p>Filter status display. When the filter is orange, we recommend that you order a new filter from your installer. To change the filter (see chapter 6.1)</p>
	<p>Manual mode activated. Warning: when this mode is active, the automatic functions are no longer operational.</p>
	<p>Malfunctioning detected. Contact your installer.</p>
	<p>Radio reception quality indicator. If the reception is bad, move your remote control closer to the VMI® unit.</p>
	<p>Battery indicator for the 2 AA LR6 batteries To change the batteries (see chapter 6.3)</p>
	<p>Indicator for the minimum set temperature for preheating the blown air. N.B. The lower the set temperature, the lower the power consumption. You are advised to cut the set temperature during the hot season.</p>
	<p>Fan operating speed indicator. In automatic mode, the speed may vary depending on various parameters to adjust the ventilation flow rate to the requirements of the premises.</p>
	<p>High outdoor humidity indicator. The intelligent VMI® unit adjusts its air flow rate to stop air that is too humid entering the premises.</p>
	<p>Ventilation cooling mode activated (automatically activated). The air flow rate is increased to cool down the premises and make your environment more comfortable during the summer.</p>
	<p>Turbo heat mode activated (automatically activated). The air flow rate is increased when the outside temperature is higher than the set temperature in winter. This means that you recover free heat.</p>
	<p>Boost mode activated (activated by the user via the specific screen). With this mode, the flow rate is increased for 30 minutes to renew the air more quickly.</p>
	<p>Holiday mode activated (activated by the user via the specific screen). With this function, the ventilation and preheat functions are set to a minimum ("freeze protection" mode) when the user is absent.</p>
	<p>STANDBY mode activated (automatically activated). The VMI® unit turns at minimum speed and deactivates air preheating if the outside temperature exceeds the maximum temperature threshold or if the VMI® unit malfunctions.</p>

3 Installation



The appliance must be installed by qualified staff.

The VMI® unit must be installed in compliance with the regulations in force: DTU 68.3.

Electrical connections must be made in accordance with the regulations in force: NFC 15-100.

For safety aspects, please refer to part [1.2 Safety rules](#).

When installing the VMI® Prestige 2 unit, you must also have a Prestige 2 radio remote control

3.1 Preparation



Before installing the appliance, remove the three foam wedges surrounding the motor inside the housing.

- Open the machine's cover by removing the 4 flat head screws.
- Remove the foam wedges and the remote control.
- Close the cover again by screwing down the 4 flat head screws.

Fix the two plastic collars supplied:

- One on the inlet and the other on the outlet. The same is true for the Compact versions. (For the Cube model housing, fix the collar plate (Ref. No. AE 003) using the 4 specific fixing points).
- Use the D3.9 L9.5 screws supplied.
- Use the pre-drilled holes on the housing. Do not pierce the housing.

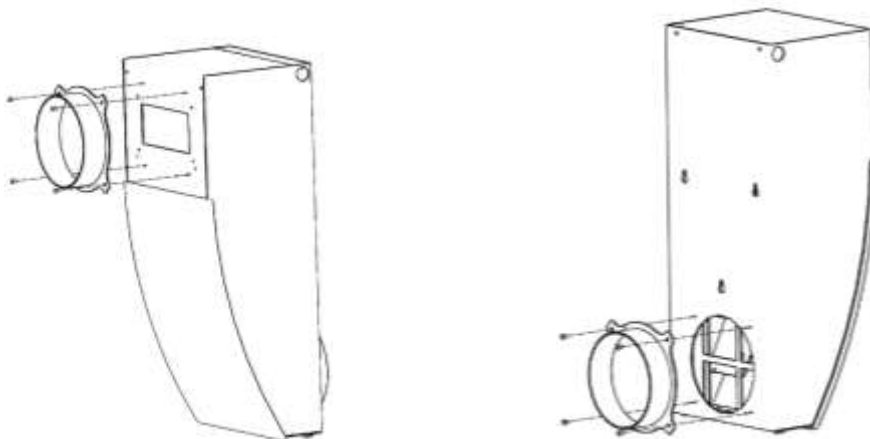

3.2 Location

The appliance must be installed away from water and frost.

The appliance must be installed so that it can be easily accessed for care and maintenance operations. If the appliance is placed in the roof space, you must allow for a trap door of at least 50x50 cm. This trap door must not be placed in a cupboard.

 Place the VMI® unit in a central position to limit the length of the ducts as much as possible and so that the ducts leading to the ventilation openings are of similar length.

3.3 Ventilation openings

3.3.1 Location

- Place the ventilation openings in the premises to ventilate.
- It is preferable to place the openings in centrally-located rooms (corridor, atrium, landing, etc.) that do not generate humidity or odours.
- Do not place ventilation openings in damp rooms (bathroom, kitchen, WC).
- Place the openings 20 cm away from obstacles (wall, beam, etc.).

3.3.2 Installation

- Trace the part to cut out: a 160 mm diameter circle.
- Cut the material with a suitable tool.
- Insert the sleeve and then the ventilation opening.

3.4 Housings

3.4.1 Ceiling-mounted housings

The Cube, Galbé and MAXI model housings can be suspended from the ceiling.

The housing may only be attached via the 4 points shown on the drawing below.

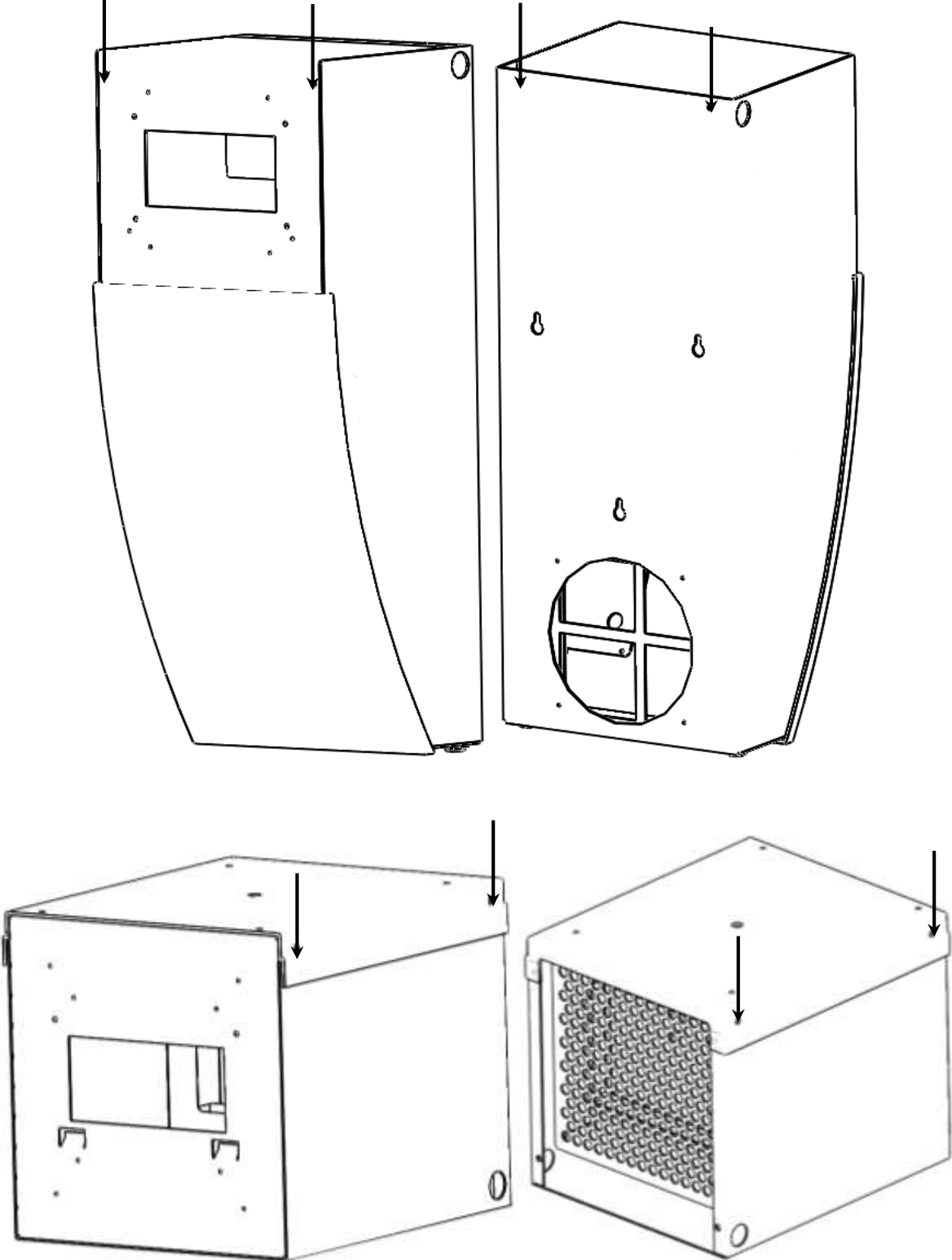

The MAXI housing can be suspended from the ceiling as long as the cover is facing upwards.

The housing may only be attached via the 4 points shown on the drawing below.

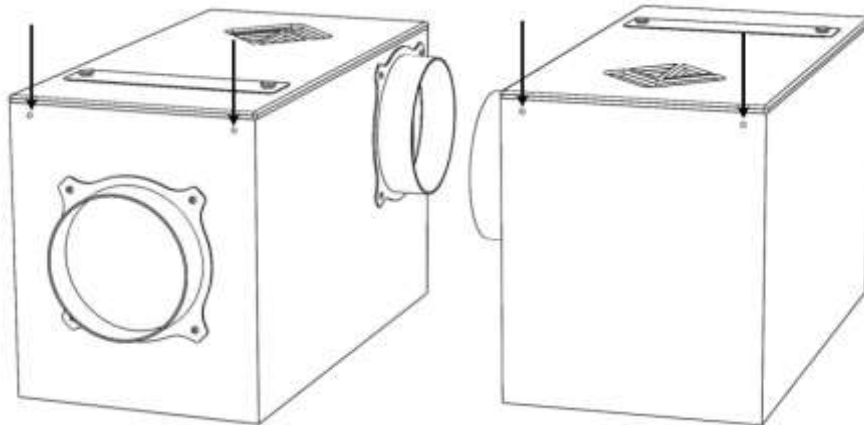

The ceiling-mounting system and the ceiling fastening points must be sized to support the weight of the housing. Ventilairsec can provide you with a ceiling chain mounting kit (Ref. No. AE 020).

3.4.2 Wall-mounted housings

Fix the Compact and Galbé model housings using 3 sufficiently large screws to support the weight of the housing.

Position the screws opposite the slotted holes shown on the below drawings.

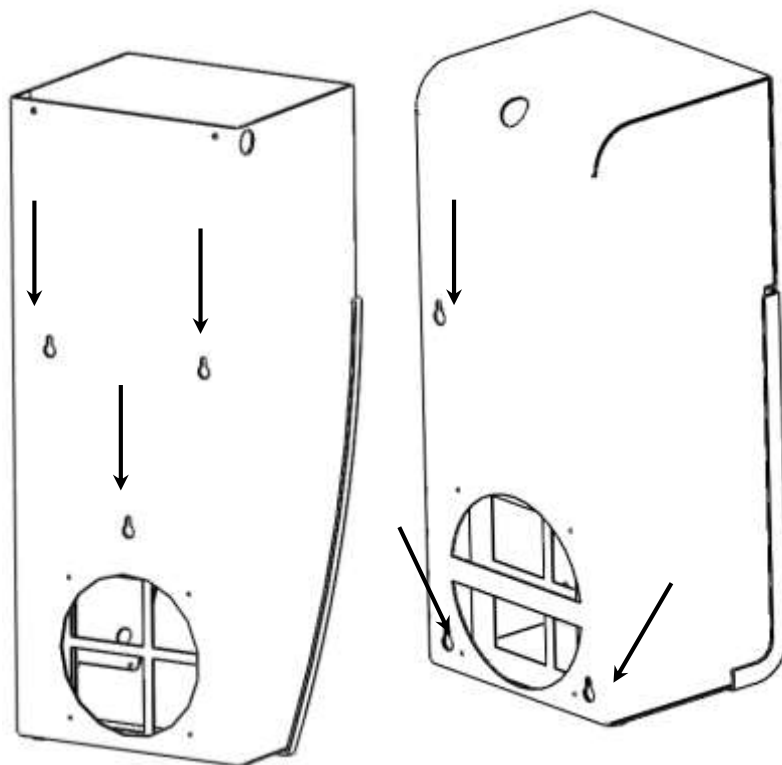

Galbé model housing

Compact model housing

The Cube model housing can also be fixed to a wall using the Cube wall-mounting frame (Ref. No. AE 019). To do this, first fix the frame to the wall using an appropriate fixing system, then insert the two tongues into one of the rear parts of the housing as shown in the following drawing by rotating the housing a quarter turn:

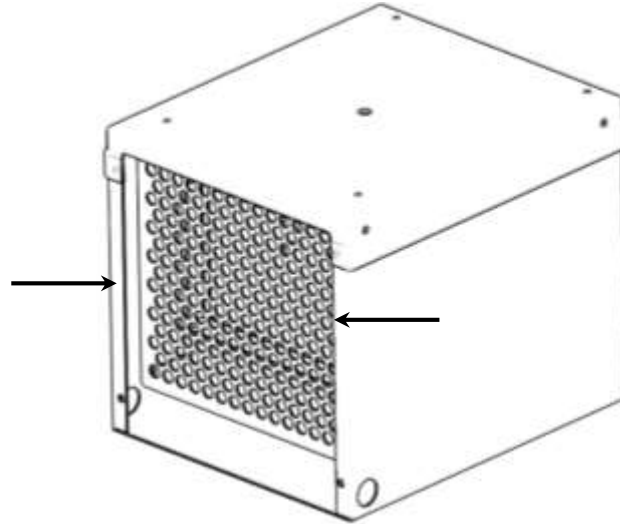

3.4.3 Free-standing housing

The housing can be free-standing as long as it is positioned for easy access to the filter. You are not advised to place it on its cover.

Make sure that the support is stable and correctly sized for the weight of the appliance.

3.5 Roof outlet

- The roof outlet must be sized for a maximum suction loss of 50 Pa at RS+2 (see [4.9 Initial settings](#) – Rated speed RS).
- The roof outlet must be placed as close as possible to the VMI® housing.
- Set the roof outlet up as indicated in its installation and operating manual and according to the type of roof.
- Make sure that it is correctly oriented to prevent rain from entering the duct network.
- For air inlets on the building façade:
 - Bore through the wall following standard practice.
 - Use a rainproof grille on the outside and optionally an insect grille if it can be accessed to be cleaned.

3.6 Duct network

- Use insulated ducts, 160 mm diameter.
- Use as few bends as possible.
- Place the duct as straight as possible.
- Make sure the network is carefully sealed, from the roof outlet to the ventilation openings.

3.6.1 Connections

- Fix a duct to the roof outlet using a clamping collar. Make sure the connection is correctly sealed.
- Cut the duct from the outlet to the right length and fix it to the VMI® unit's inlet collar. Use a clamping collar and make sure it is correctly sealed.
- Fix new ducts (one per ventilation opening) to the sleeves using clamping collars. Make sure the connection is correctly sealed.
- (4V and 6V types) Cut the ducts from the ventilation openings' sleeves to the right length and fix them to the two coaxial ends of the connecting tee. Both ducts must be of similar length and as short as possible. Use clamping collars and make sure the connections are correctly sealed.
- (4V and 6V types) Fix a duct to the third end of the connecting tee. Use a clamping collar and make sure it is correctly sealed.
- (4V and 6V types) Cut the duct from the tee to the right length and fix it to the VMI® unit's outlet collar. Use a clamping collar and make sure it is correctly sealed.
- Cut the duct from the ventilation opening's sleeve to the right length and fix it to the VMI® unit's outlet collar. Use a clamping collar and make sure it is correctly sealed.

3.7 Summary of the installation

- 1. Put the sleeves in place,
- 2. Position the housing in the centre,
- 3. Place the roof outlet as close as possible to the housing,
- 4. Connect the ducts with the collars.

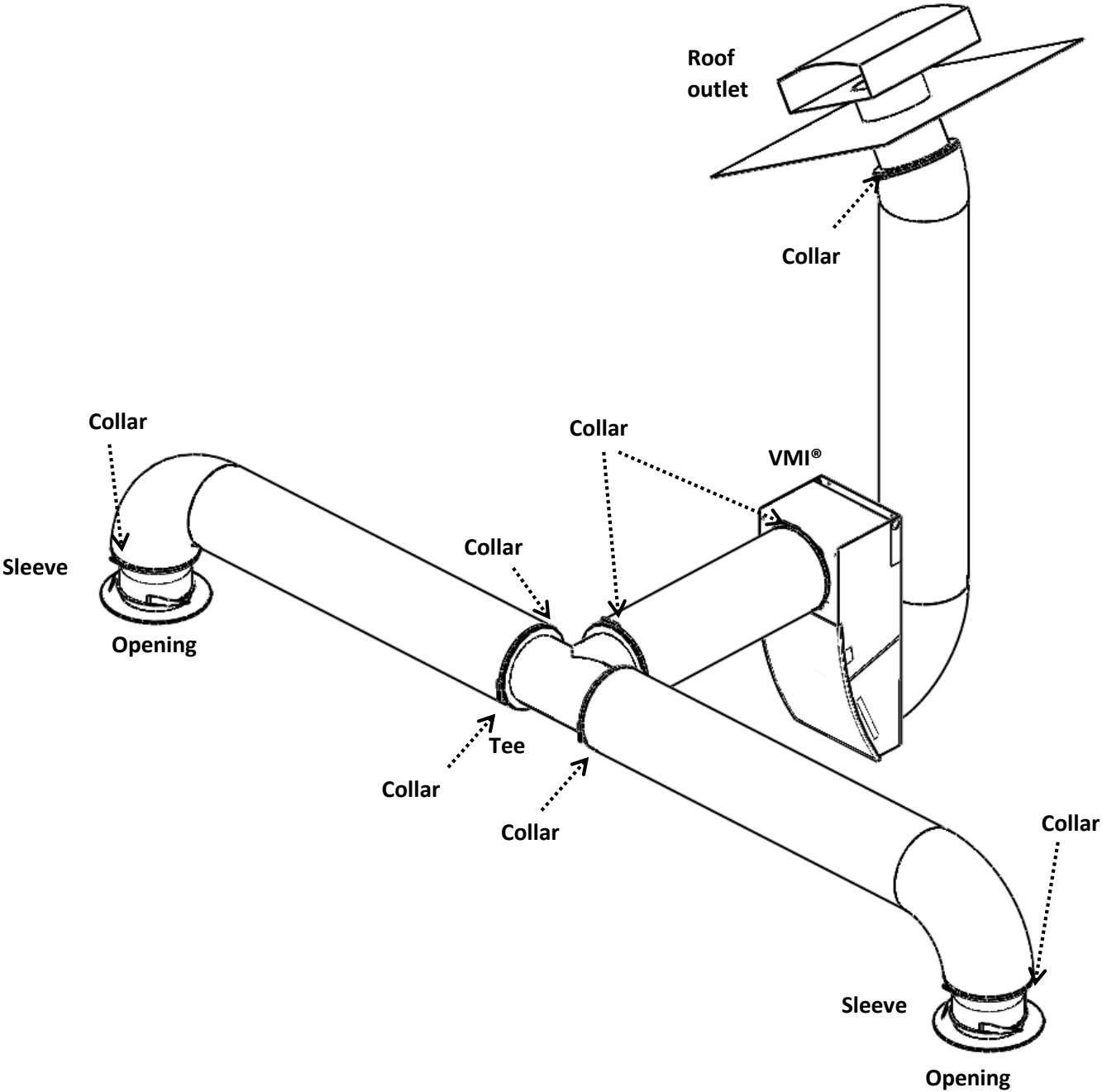

**non-contractual schematic diagram*

3.8 Electrical connection

The appliance must be connected by a professional in compliance with the French standard NFC 15-100.



This step must only be done when the other installation steps are finished. This avoids any risk of electric shocks when installing the various parts of the system.

The VMI® unit must be connected to a dedicated line. On the switchboard, the installation must be equipped with a 16 A bipolar circuit breaker, a 30 mA differential circuit breaker and a means for disconnecting in the fixed line.

Connect the supplied cable to the mains via a sealed junction box (not supplied).

Type of cable: 3 x 1.5 mm² with ground conductor.

Single phase 230 VAC, 50 Hz

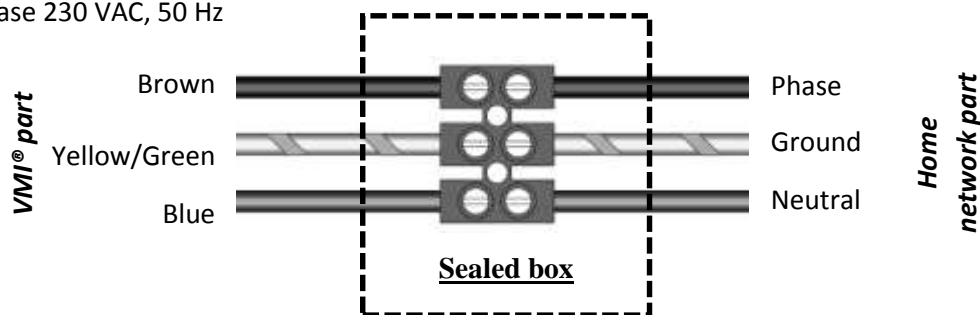

3.9 Remote control

If the premises are equipped with a heating thermostat, the remote control should preferably be placed next to it. If not, it should be placed in a living area, as it measures the relative ambient humidity and controls the ventilation flow rate. It must never be placed above a radiator, close to a source of cold, under a ventilation opening or closed in a cupboard or drawer.

The remote control can either be placed on a horizontal surface or fixed to the wall via the 2.5 mm diameter hole on the back of the remote control.

If the remote control is fixed to the wall, check the radio connection before installing the fixing system. Any obstacles between the remote control and the VMI® unit reduce the maximum range of the radio communication (walls, metal objects, floors, etc.).

If you are using the system to cure damp, place the remote control in the room to be treated so that the VMI® unit can adjust its ventilation flow rate to the humidity rate in the room.

3.10 Air extraction points

All rooms in the premises, even if they have no windows or do not have an outside wall, must be equipped with a natural air extraction point (trickle vent, wall duct). If they do not, extraction points must be made following standard practice.

To correctly adjust the extraction grilles, distribute 90% of the air blown into the premises between all of the rooms.



Measures must be taken to avoid gas backdrafts in the room from the exhaust pipes of gas appliances or other open fire appliances (for the duct fans and the partition wall fans).

All other extraction devices installed under other regulations (e.g. gas appliances) must not be altered.

3.11 Door undercuts

Undercuts must be made under all doors in the premises. The space required between the floor and the bottom of the door is as follows:

- 1 cm for all doors including the kitchen door if it has at least 2 access doors.
- 2 cm for the kitchen door if it has only one access door and for all doors to rooms equipped with an appliance connected to the gas.



4 Commissioning

The appliance must be installed by qualified staff.

4.1 Proper completion checks

In accordance with the DTU 68.3, a visual inspection must be carried out after the installation to check that:

- The sizing specifications are respected,
- The installation is safe (electrically, mechanically),
- The system's components are in good condition,
- The remote control and other components can be accessed for maintenance.

 Make sure that the foam wedges inside the machine have been removed.

4.2 Powering up for the first time / Pairing

Open the battery compartment on the rear of the remote control and insert the batteries. Close the battery compartment. The following screen appears:



Update the date and time on the remote control using the  buttons. Wait until the remote control asks for the pairing.



Turn on the VMI® unit and press the  button within 30 seconds after turning on the VMI® unit.

If the connection fails, press  to start the procedure again.

Tip: move closer to the VMI® unit if you have problems connecting

4.3 Accessing the installer mode/configuration mode

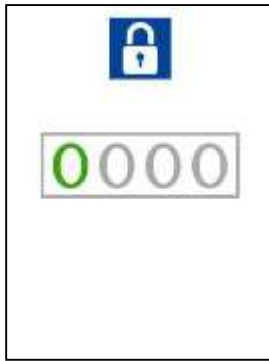

To correctly set the VMI® unit, you must use the remote control's installer mode. To do this, press the  button until you get to the following screen:

The installer code is **1919**.

Press the  buttons to change the value of the selected number. To

confirm and move on to the next number, press .

The value of the code is only checked on the last number after pressing the  button. The following screen appears:



Choose your language by pressing the  buttons then press

 to confirm.

Check that the date and time are correct.

Use the  button to return to the main screen.

4.4 Setting the rated speed/filter duration

Once you are in the installer mode, you should first get the rated speed setting screen. If not, press the



button as many times as necessary to get to the following screen:



To know what speed and what filter duration you should set, refer to chapter [4.9 Initial settings](#).



Use the buttons to select the field to change. The button



confirms the new value and sends it to the VMI® unit. If the VMI® unit has received the new value, the

value is displayed in green. If not, the old value remains displayed in green. The



button cancels the change, displays the old value in green and returns to the field selection.

When you are selecting the field to change, use the



button to move on to the "consumption and operating time" screen.

4.5 Consumption and operating time screen

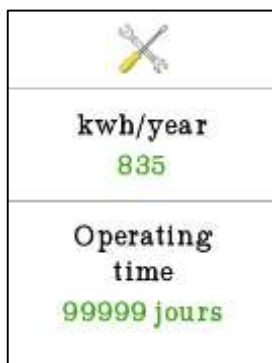

This screen shows the approximate cumulative consumption of the VMI® unit in kWh year on year and the number of days the VMI® unit has been in operation since it was commissioned.



Use the button to move on to the troubleshooting screen.

days

4.6 Troubleshooting

This screen helps the installer with troubleshooting.

Important: a test must be run to update the fault codes. Only the probes are automatically updated.

TRST

OK to start ?

Once the test has finished, the system status is displayed

	Motor status
	Preheat status
	VMI® unit's probe status
	This probe is not active in this version
	Remote control's probe status

N.B. Probe No. 2 is always displayed even if it is not present on the VMI® unit. If there is only one probe, no status is shown for the second probe.

Normal operation Abnormal operation.

Use the button to move on to the version screen.

The VMI® unit test is for troubleshooting purposes only and in no way replaces the expertise of an installer. We recommend that installers have a fully-equipped repair case with them during repair visits and that they carry out the necessary electrical tests to confirm the failure signalled by the system. Also, certain failures may conceal others.

4.7 Version screen

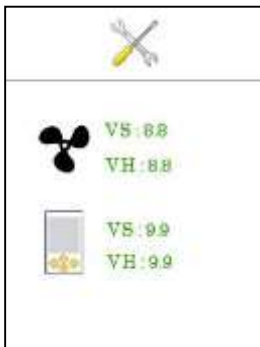



This screen shows the VMI® unit's and the remote control's software and hardware versions. This information may be requested for technical monitoring or assistance.

Use the  button to move on to exit the installer mode.

4.8 Exiting the installer mode



Press the  buttons to select "yes" or "no", and  to confirm the selection.

If "yes" is selected, the main screen appears.

If "no" is selected, the "language/date" screen appears.

4.9 Initial settings

Parameters:

In the installer mode, you can set the 2 parameters shown in the following table.

Parameter	Description	Factory setting	In situ setting
Rated speed (RS)	Speed at which the VMI® unit operates in automatic mode in normal conditions.	V9	To be adjusted for the volume to ventilate to ensure a renewal rate of 0.5 volume/hour. → See table below
Max filter	Filter usage duration before filter change warning is displayed	200 days	The setting depends on the premises' surrounding environment.

Choosing the Rated Speed:

The rated speed should be set to correspond to the volume to ventilate or the surface area of the premises.

For the Galbé and Cube models:

Surface area of the space to ventilate* (m ²)	Volume to ventilate (m3)	Rated speed to set*
0 to 24	0 to 60	V1
25 to 61	60 to 154	V2
62 to 74	155 to 184	V3
75 to 80	185 to 200	V4
81 to 90	201 to 224	V5
91 to 97	225 to 242	V6
98 to 122	243 to 306	V7
123 to 148	307 to 370	V8
149 to 164	371 to 410	V9
165 to 174	411 to 436	V10

For the Compact model:

Surface area of the space to ventilate* (m ²)	Volume to ventilate (m3)	Rated speed to set*
0 to 16	0 to 40	V1
17 to 24	41 to 60	V2
25 to 31	61 to 80	V3
32 to 40	81 to 100	V4
41 to 48	101 to 120	V5
49 to 56	121 to 140	V6
57 to 68	140 to 170	V7
69 to 80	171 to 200	V8
81 to 96	201 to 240	V9
97 to 136	241 to 340	V10

For the MAXI model housing:

Surface area of the space to ventilate* (m ²)	Volume to ventilate (m3)	Rated speed to set*
0 to 87	0 to 217	V1
88 to 131	220 to 327	V2
132 to 157	330 to 392	V3
158 to 182	395 to 455	V4
183 to 207	457 to 517	V5
208 to 232	520 to 580	V6
233 to 257	582 to 642	V7
258 to 282	645 to 705	V8
283 to 307	707 to 767	V9
308 to 320	770 to 800	V10

* for premises with an unchanging ceiling height of 2.5 m.

5 Getting started

In compliance with DTU 68.3, the installer/contractor must:

- Clearly explain the reasons for ventilating (Indoor Air Quality),
- Explain the technical aspects of the appliance,
- Explain the operation of the appliance,
- Give specific information on the appliance (always in operation during the intended periods, do not obstruct the air inlets and outlets, clearance under doors, etc.),
- Remind the user of the care and maintenance instructions given in the installation and operating manuals and that the ventilation must never be stopped
- Give the user the operating manual.

6 Care

6.1 Filter

The VMI® PULSE'R Prestige 2 unit is equipped with a grade G4 filter.

The VMI® PULSE'R Prestige 2 + unit is equipped with a grade F7 filter.

(For 3V or 4V installations, the VMI® PULSE'R Prestige 2 + unit is also equipped with a G4 sleeve filter)

To ensure optimum air quality and correct functioning of the VMI® unit, the filter must be regularly changed.

Changing the filter

- Order a new filter from VENTILAIRSEC.
- Access the VMI® unit.
- Manually unscrew the 2 plastic head screws on the filter compartment.
- Remove the old filter.

 **WARNING:** do not insert anything in the machine apart from the new filter.

- Insert the new filter.
 - For a G4 filter: the blue part of the filter must be facing the outside of the machine.
 - For an F7 filter: the tab on the filter must be pointing towards the outside of the VMI® unit.

The new filter must be quickly inserted after the old one is removed.

- Screw down the 2 plastic head screws.
- Reset the filter counter (number of days used) on the remote control (see [6.2 Resetting the filter counter](#), Care section).

 **WARNING:** when changing the filter, only the drawer must be removed. You may get an electric shock, get burnt or cut yourself if you open the housing.

6.2 Resetting the filter counter



This screen appears in the user mode:



Use the  buttons to select the "Reset" pictogram:



Use the  button to confirm, after which the "new filter?" message and the YES/NO buttons (on NO by default) appear.

Use the  buttons to choose YES or NO: 

Use the  button to confirm and if YES is active, then the filter counter reset request will be taken into account. The number of days displayed automatically changes to 0.

6.3 Batteries

Changing the remote control's batteries

- You need 2 new LR6/AA batteries.
- With your thumbs, slide the cover down to open it.
- Remove the dead batteries.
- Insert the new batteries.
- Close the cover by sliding it up.

The batteries must not be thrown away with household rubbish. To dispose of them in compliance with local standards, take them to your local collection point or return them to your retailer or manufacturer.



Important: If the operation lasts more than 2 minutes, the time must be reset on the remote control. When you start up again, the following screen appears:

If the time has not been reset, it will display the last time saved.



6.4 SD card



An SD card is inserted in the remote control. It must not be removed by the user under any circumstances, unless requested by a professional partner of VENTILAIRSEC. This card collects various data for maintenance.

6.5 **Air inlets and outlets**

Every 6 months, remove the dust from the ventilation openings and the air extraction grilles with a clean, dry cloth and a small brush.



6.6 **Cleaning/checking**

Operation that cannot be done by the user.

6.6.1 Cleaning

The machine must be thoroughly cleaned once a year (preferably in autumn), either as part of a maintenance contract or when requested by the user.

Cleaning the machine

-  Cut all power to the VMI® unit before intervening and make sure that it cannot be accidentally reset.
- Open the machine's cover by removing the 4 flat head screws.
- Remove the dust from the fan's wheel using a blower or a dry brush.
- Remove the dust from the resistors using a blower or a dry brush.
- Wipe the inside of the housing with a clean cloth.
- Close the cover again by screwing down the 4 flat head screws.

6.6.2 Checks

To make sure the appliance remains effective, it is important to check the following points:

- The condition of the duct system. Clean or change it if necessary.
- The roof outlet or the suction grille must be clear and not obstructed by anything (nest, leaves, etc.). If it is obstructed, clean it following the safety rules.
- The various air passages (openings, grilles, ventilation under doors). They must be clear and not reduced in size.

7 Glossary

Air quality: assessment of the state of the ambient air according to a scale measuring the rate of concentration of pollutants.

Condensation: physical phenomenon resulting in the appearance of water droplets when warm air comes into contact with a cold surface.

Cut-off temperature: see *4.9 Initial settings*.

Door undercuts: removing a small part at the bottom of a door so that the air can flow underneath it.

Flow rate (air/ventilation): volume of blown air over a certain period.

Load loss: organ or irregularity impeding the flow of air.

Pairing: creating a pair, i.e. two communicating appliances recognise each other. In this case, the VMI® unit and the remote control recognise each other.

Positive ventilation: air injected into the premises.

Preheat temperature: temperature at which the VMI® unit preheats the air blown into the premises if the temperature of air it draws in is lower.

Premises: space to ventilate - house, offices, public premises, etc.

Relative humidity: Rate of humidity in the air as a percentage.

Renewal rate: number of times the air in the premises is renewed every hour.

RS: Rated speed. The VMI® set speed for the volume to be ventilated.

VMI®: Positive Input Ventilation.